



# ProV™ 200 Series Picture & Transom Parts Reference Catalog

#563173

FOR PRODUCT PRODUCED AFTER 05/94

Transom Direct Set

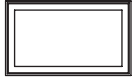

Picture Direct Set



Use with:

- 930 Single Hung
- 930 Double Hung
- 930 Gliding Window

PICTURE & TRANSOM

Mull/Stack



Use with:

- 930 Single Hung
- 930 Double Hung

**NOTE:**

Gliding Windows CANNOT be mullied or stacked with the 930 Picture & Transom units OR with another Gliding Window.

MULL/STACK

Order Form



ORDER FORM



**TABLE OF CONTENTS:**

Picture & Transom Exploded View	1
Replacement Parts/Accessories	2
Standard Catalog Size Charts	5

**DESCRIPTION:**

All vinyl direct set window.

**FRAME OPTIONS:**

White or Sandtone

**DISTINGUISHING FEATURES:**

Full 3 1/4" main frame

**HOW TO ORDER A PART:**

Identify the part using the exploded views and indexes. Reference the part in the Replacement Parts/Accessories Section beginning on page 2, using the number from the index.

**When ordering replacement parts, unit must be viewed from the exterior.**

**GLASS IDENTIFICATION CODE:**

The glass code number references the date of manufacture, which is helpful in identifying the product.

**When ordering warranty replacement glass, sash or panels, it is necessary to specify the glass identification code.** Markings are stamped on one of the four sides of the spacer channel which separates the two panes of glass. (Refer to the illustration at right)

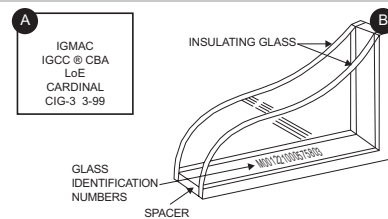

Markings are etched in the glass (A) or are printed/stamped on one of the four sides of the spacer channel which separates the two panes of glass (B).

**MEASURING VISIBLE GLASS:**

Typically, a part can be ordered by specifying catalog size or visible glass. The visible glass dimensions can be determined by measuring the width and the height of the exposed glass on the sash from inside the home. (Refer to arrows on the illustration at right)

**Measurements within + or - 1/4" will be rounded to the nearest standard size as given in the tables on the Standard Catalog Size Charts. Visible glass dimensions that are greater or less than 5/16" of a standard size means it is a custom size window.**

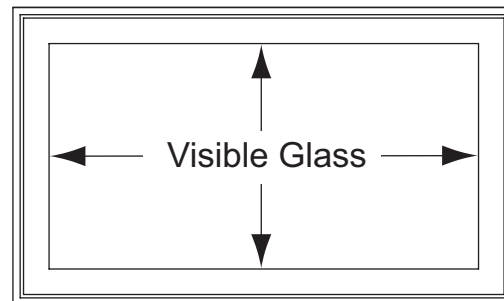

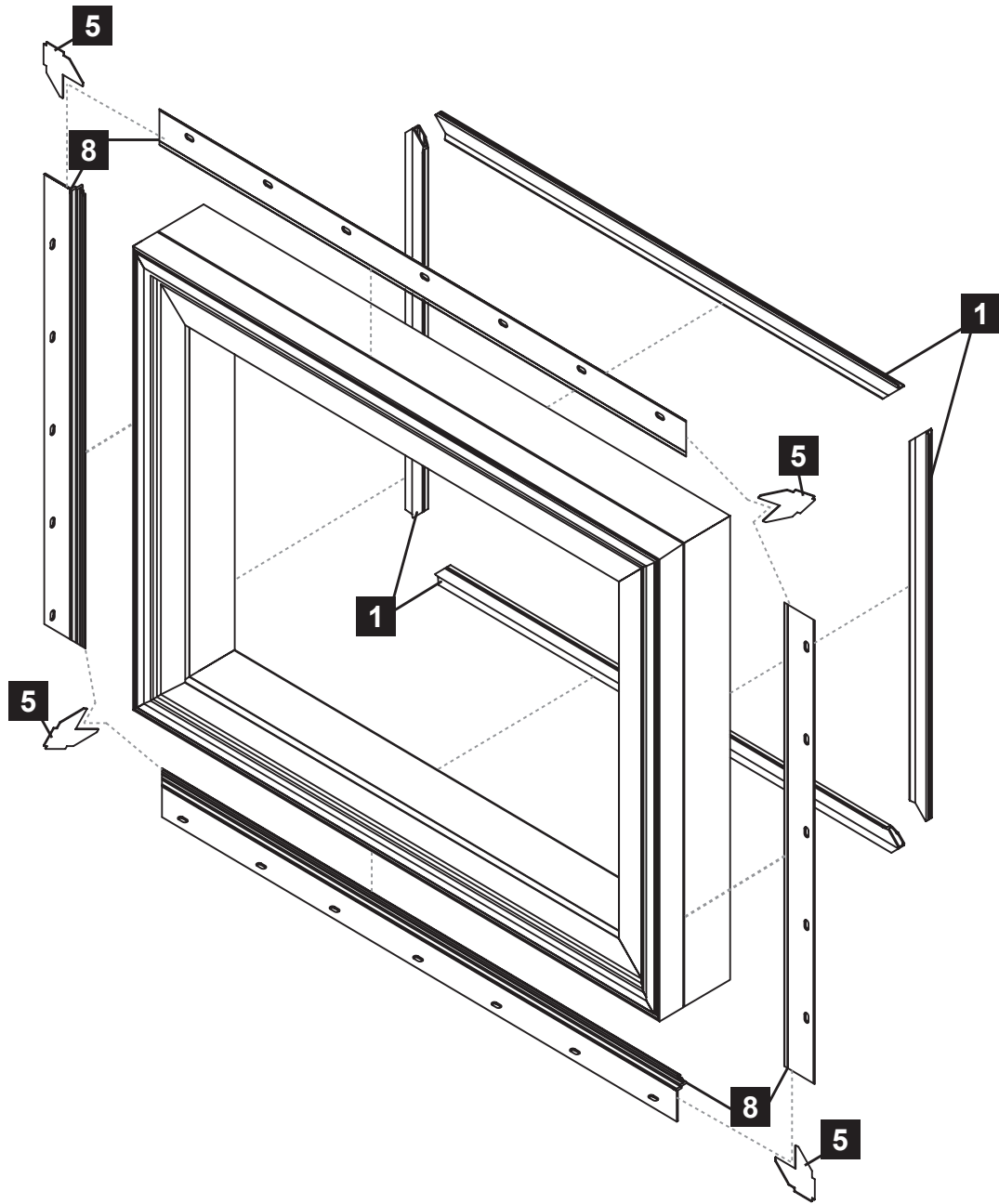

**Parts Shown**

- 1** Glazing Bead Pkg..... pg. 2
- 5** Corner Gusset ..... pg. 2
- 8** Rigid Nail Fin ..... pg. 3

**Parts Not Shown**

- 2** Glazing Bead Pkg (Radius Units only) ..... pg. 2
- 3** Jamb Extender Pkg ..... pg. 2
- 4** Glass Shim ..... pg. 2
- 6** Metal Joining/Install Plate..... pg. 2
- 7** Extension Jamb Clip..... pg. 3
- 9** **17** Accessories ..... pg. 3-4

**Note: When ordering replacement parts,  
unit must be viewed from exterior.**

**1 Glazing Bead Package**

Specify Catalog Size \_\_\_\_\_  White  Sandtone  
(See pages 5-11)

**2 Glazing Bead Package**

Specify Catalog Size \_\_\_\_\_  White  Sandtone  
(See pages 5-11)

*Used for Radius Units only.*

**3 Jamb Extender Package**

4 9/16"  6 13/16"  
 6 9/16"  7 1/16"

**4 3/32" Glass Shim**

**STYLE: MISC**

**5 Corner Gusset (pkg. of 4)**

**STYLE: MISC**

**6 Metal Joining/Installation Plate**

**FASTENERS NOT INCLUDED**

**STYLE: MISC**

*Drawings not to scale.*

**7** Extension Jamb Clip (pkg. of 16)

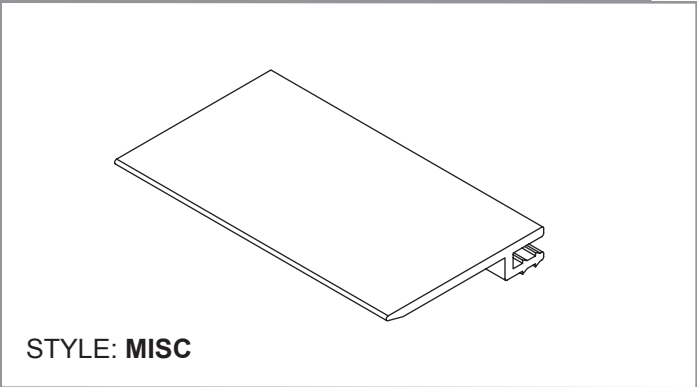

**8** Rigid Nail Fin

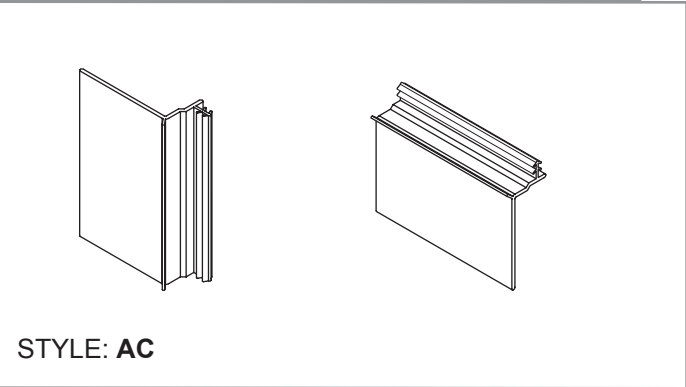

**9** Trim Connector

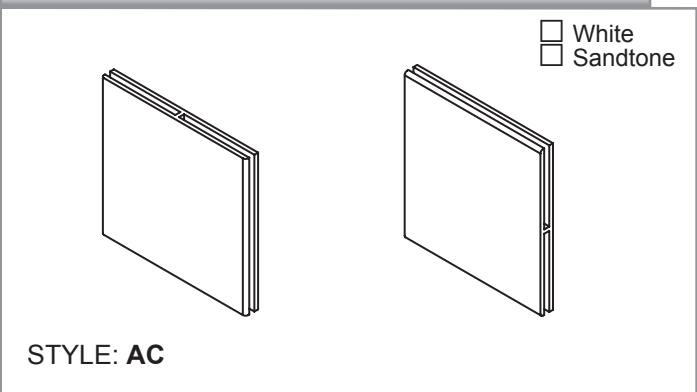

**10** 5/8" J-Channel

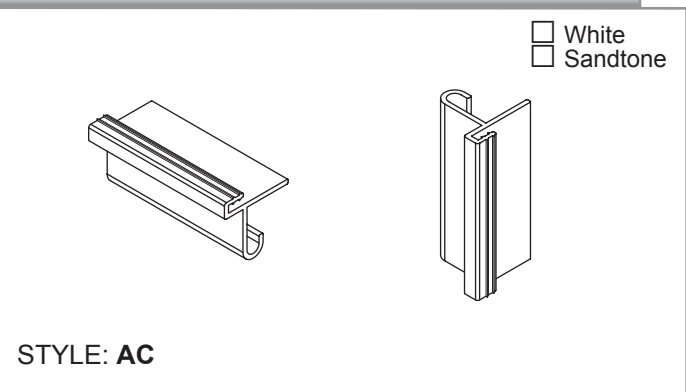

**11** 7/8" J-Channel

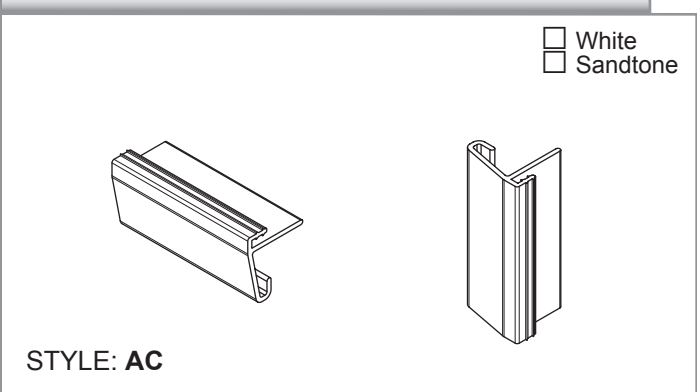

**12** Simulated Flat Casing

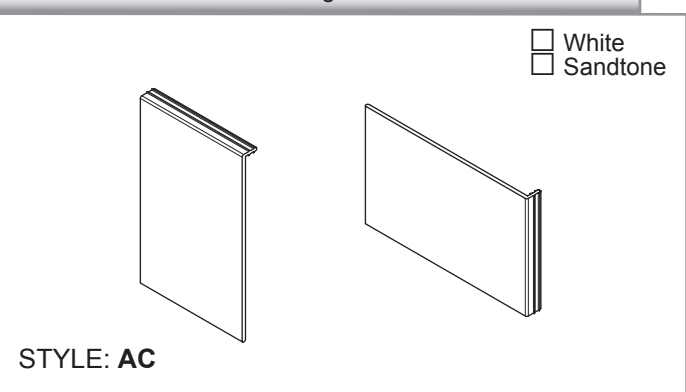

**13 Flat Casing Return**

White  
 Sandtone

STYLE: AC

**14 Drywall Receptor**

1/2" Shown

1/2"  
 5/8"  
 Measurements pertain to drywall thickness.  
 White  
 Sandtone

STYLE: AC

*Viewed from the interior.*

**15 3/4" Trim Receptor**

White  
 Sandtone

STYLE: AC

*Viewed from the interior.*

**16 Masonry Flange**

White  
 Sandtone

STYLE: AC

**17 Brickmould Casing**

White  
 Sandtone

STYLE: AC

Drawings not to scale.

### Direct Set Picture Units

(sized for Single Hung/Gliding Windows)

Unit Dimension	2'-11 1/2"	3'-5 1/2"	3'-11 1/2"	4'-11 1/2"	5'-11 1/2"
Rough Opening	3'-0"	3'-6"	4'-0"	5'-0"	6'-0"
Soft Metric R.O. (mm)	914	1067	1219	1524	1829
Visible Glass	31 1/4"	37 1/4"	43 1/4"	55 1/4"	67 1/4"
2'-11 1/2" x 3'-0"	3030	3630	4030	5030	6030
3'-5 1/2" x 3'-6"	3036	3636	4036	5036	6036
3'-11 1/2" x 4'-0"	3040	3640	4040	5040	6040
4'-5 1/2" x 4'-6"	3046	3646	4046	5046	6046
4'-11 1/2" x 5'-0"	3050	3650	4050	5050	6050
5'-5 1/2" x 5'-6"	3056	3656	4056	5056	6056
5'-11 1/2" x 6'-0"	3060	3660	4060	5060	6060

NOTE: Shaded units meet DP50 ratings when DP50 option is selected.





### Direct Set Picture Units (sized for Double Hung Windows)





Unit Dimension	3' 5-1/2"	4' 5-1/2"	5' 1-1/2"	5' 9-1/2"
Rough Opening	3' 6"	4' 6"	5' 2"	5' 10"
Soft Metric R.O. (mm)	1067	1372	1575	1778
Visible Glass	37-1/4"	49-1/4"	57-1/4"	65-1/4"
4' 4-1/8"				
4' 8-1/8"				
5' 0-1/8"				
5' 4-1/8"				
5' 8-1/8"				
5' 8-1/8"				
6' 0-1/8"				

Standard Colonial Grille Patterns Shown.  
NOTE: Shaded units meet DP50 unit ratings when DP50 option is selected.







### Direct Set Transom Units



(sized for Single Hung Windows)







				
Base Code	TRNA-1616	TRNA-2016	TRNA-2616	TRNA-3016
Unit Dimension	1' 5-1/2" x 1' 5-1/2"	1' 11-1/2" x 1' 5-1/2"	2' 5-1/2" x 1' 5-1/2"	2' 11-1/2" x 1' 5-1/2"
Rough Opening	1' 6" x 1' 6"	2' 0" x 1' 6"	2' 6" x 1' 6"	3' 0" x 1' 6"
Soft Metric R.O. (mm)	457 x 457	610 x 457	762 x 457	914 x 457
Visible Glass	13-1/4" x 13-1/4"	19-1/4" x 13-1/4"	25-1/4" x 13-1/4"	31-1/4" x 13-1/4"





				
Base Code	TRNA-3616	TRNA-4016	TRNA-5016	TRNA-6016
Unit Dimension	3' 5-1/2" x 1' 5-1/2"	3' 11-1/2" x 1' 5-1/2"	4' 11-1/2" x 1' 5-1/2"	5' 11-1/2" x 1' 5-1/2"
Rough Opening	3' 6" x 1' 6"	4' 0" x 1' 6"	5' 0" x 1' 6"	6' 0" x 1' 6"
Soft Metric R.O. (mm)	1067 x 457	1219 x 457	1524 x 457	1829 x 457
Visible Glass	37-1/4" x 13-1/4"	43-1/4" x 13-1/4"	55-1/4" x 13-1/4"	67-1/4" x 13-1/4"

(sized for Double Hung Windows)

							
Base Code	TRNA-1812	TRNA-2012	TRNA-2412	TRNA-2812	TRNA-3012	TRNA-3412	TRNA-4412
Unit Dimension	1' 9-1/2" x 1' 3-1/2"	2' 1-1/2" x 1' 3-1/2"	2' 5-1/2" x 1' 3-1/2"	2' 9-1/2" x 1' 3-1/2"	3' 1-1/2" x 1' 3-1/2"	3' 5-1/2" x 1' 3-1/2"	4' 5-1/2" x 1' 3-1/2"
Rough Opening	1' 10" x 1' 4"	2' 2" x 1' 4"	2' 6" x 1' 4"	2' 10" x 1' 4"	3' 2" x 1' 4"	3' 6" x 1' 4"	4' 6" x 1' 4"
Soft Metric R.O. (mm)	559 x 406	660 x 406	762 x 406	864 x 406	965 x 406	1067 x 406	1372 x 406
Visible Glass	17-1/4" x 11-1/4"	21-1/4" x 11-1/4"	25-1/4" x 11-1/4"	29-1/4" x 11-1/4"	33-1/4" x 11-1/4"	37-1/4" x 11-1/4"	49-1/4" x 11-1/4"

		
Base Code	TRNA-5012	TRNA-5812
Unit Dimension	5' 1-1/2" x 1' 3-1/2"	5' 9-1/2" x 1' 3-1/2"
Rough Opening	5' 2" x 1' 4"	5' 10" x 1' 4"
Soft Metric R.O. (mm)	1575 x 406	1778 x 406
Visible Glass	57-1/4" x 11-1/4"	65-1/4" x 11-1/4"

						
Base Code	TRNA2-1812	TRNA2-2012	TRNA2-2412	TRNA2-2812	TRNA2-3012	TRNA2-3412
Unit Dimension	3' 7-1/2" x 1' 3-1/2"	4' 3-1/2" x 1' 3-1/2"	4' 11-1/2" x 1' 3-1/2"	7' 7-1/2" x 1' 3-1/2"	6' 3-1/2" x 1' 3-1/2"	6' 11-1/2" x 1' 3-1/2"
Rough Opening	3' 8" x 1' 4"	4' 4" x 1' 4"	5' 0" x 1' 4"	5' 8" x 1' 4"	6' 4" x 1' 4"	7' 0" x 1' 4"
Soft Metric R.O. (mm)	1118 x 406	1321 x 406	1524 x 406	1727 x 406	1930 x 406	2134 x 406
Visible Glass	17-1/4" x 11-1/4"	21-1/4" x 11-1/4"	25-1/4" x 11-1/4"	29-1/4" x 11-1/4"	33-1/4" x 11-1/4"	37-1/4" x 11-1/4"

					
Base Code	TRNA3-1812	TRNA3-2012	TRNA3-2412	TRNA3-2812	TRNA3-3012
Unit Dimension	5' 5-1/2" x 1' 3-1/2"	6' 5-1/2" x 1' 3-1/2"	7' 5-1/2" x 1' 3-1/2"	8' 5-1/2" x 1' 3-1/2"	9' 5-1/2" x 1' 3-1/2"
Rough Opening	5' 6" x 1' 4"	6' 6" x 1' 4"	7' 6" x 1' 4"	8' 6" x 1' 4"	9' 6" x 1' 4"
Soft Metric R.O. (mm)	1676 x 406	1981 x 406	2286 x 406	2591 x 406	2896 x 406
Visible Glass	17-1/4" x 11-1/4"	21-1/4" x 11-1/4"	25-1/4" x 11-1/4"	29-1/4" x 11-1/4"	33-1/4" x 11-1/4"

Drawings not to scale.

### Direct Set Transom Units

(sized for Gliding Windows)

PICTURE & TRANSOM









Base Code	TRNA-2616	TRNA-3016	TRNA-3616	TRNA-4016
Unit Dimension	2' 5-1/2" x 1' 5-1/2"	2' 11-1/2" x 1' 5-1/2"	3' 5-1/2" x 1' 5-1/2"	3' 11-1/2" x 1' 5-1/2"
Rough Opening	2' 6" x 1' 6"	3' 0" x 1' 6"	3' 6" x 1' 6"	4' 0" x 1' 6"
Soft Metric R.O. (mm)	762 x 457	914 x 457	1067 x 457	1219 x 457
Visible Glass	25-1/4" x 13-1/4"	31-1/4" x 13-1/4"	37-1/4" x 13-1/4"	43-1/4" x 13-1/4"





Base Code	TRNA-4616	TRNA-5016	TRNA-6016
Unit Dimension	4' 5-1/2" x 1' 5-1/2"	4' 11-1/2" x 1' 5-1/2"	5' 11-1/2" x 1' 5-1/2"
Rough Opening	4' 6" x 1' 6"	5' 0" x 1' 6"	6' 0" x 1' 6"
Soft Metric R.O. (mm)	1372 x 457	1524 x 457	1829 x 457
Visible Glass	49-1/4" x 13-1/4"	55-1/4" x 13-1/4"	67-1/4" x 13-1/4"

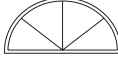

### 1/2 Round Direct Set Radius Units (sized for Single Hung Windows)

Base Code	 HRA1-20	 HRA1-26	 HRA1-30	 HRA1-36
Unit Dimension	1' 11-1/2" x 1' 1-1/8"	2' 5-1/2" x 1' 4-1/8"	2' 11-1/2" x 1' 7-1/8"	3' 5-1/2" x 1' 10-1/8"
Rough Opening	2' 0" x 1' 1-5/8"	2' 6" x 1' 4-5/8"	3' 0" x 1' 7-5/8"	3' 6" x 1' 10-5/8"
Soft Metric R.O. (mm)	610 x 346	762 x 422	914 x 498	1067 x 575
Visible Glass	19-1/4" x 8-7/8"	25-1/4" x 11-7/8"	31-1/4" x 14-7/8"	37-1/4" x 17-7/8"

Base Code	 HRA1-40	 HRA1-50	 HRA1-60
Unit Dimension	3' 11-1/2" x 2' 1-1/8"	4' 11-1/2" x 2' 7-1/8"	5' 11-1/2" x 3' 1-1/8"
Rough Opening	4' 0" x 2' 1-5/8"	5' 0" x 2' 7-5/8"	6' 0" x 3' 1-5/8"
Soft Metric R.O. (mm)	1219 x 651	1524 x 803	1829 x 956
Visible Glass	43-1/4" x 20-7/8"	55-1/4" x 26-7/8"	67-1/4" x 32-7/8"







### 1/4 Round Direct Set Radius Units (sized for Single Hung Windows)







Base Code	 QRA1-26	 QRA1-30	 QRA1-36
Unit Dimension	2' 5-1/2" x 2' 5-1/2"	2' 11-1/2" x 2' 11-1/2"	3' 5-1/2" x 3' 5-1/2"
Rough Opening	2' 6" x 2' 6"	3' 0" x 3' 0"	3' 6" x 3' 6"
Soft Metric R.O. (mm)	762 x 762	914 x 914	1067 x 1067
Visible Glass	25-1/4" x 25-1/4"	31-1/4" x 31-1/4"	37-1/4" x 37-1/4"

Base Code	 QRA1-40	 QRA1-50
Unit Dimension	3' 11-1/2" x 3' 11-1/2"	4' 11-1/2" x 4' 11-1/2"
Rough Opening	4' 0" x 4' 0"	5' 0" x 5' 0"
Soft Metric R.O. (mm)	1219 x 1219	1524 x 1524
Visible Glass	43-1/4" x 43-1/4"	55-1/4" x 55-1/4"

### Modified Eyebrow Direct Set Units







(sized for Double Hung Windows)







							
Base Code	MEA1-1812	MEA1-2012	MEA1-2412	MEA1-2812	MEA1-3012	MEA1-3412	MEA1-4412
Unit Dimension	1' 9-1/2" x 1' 3-1/2"	2' 1-1/2" x 1' 3-1/2"	2' 5-1/2" x 1' 3-1/2"	2' 9-1/2" x 1' 3-1/2"	3' 1-1/2" x 1' 3-1/2"	3' 5-1/2" x 1' 3-1/2"	4' 5-1/2" x 1' 3-1/2"
Rough Opening	1' 10" x 1' 4"	2' 2" x 1' 4"	2' 6" x 1' 4"	2' 10" x 1' 4"	3' 2" x 1' 4"	3' 6" x 1' 4"	4' 6" x 1' 4"
Soft Metric R.O. (mm)	559 x 406	660 x 406	762 x 457	864 x 406	965 x 406	1067 x 406	1372 x 406
R.O. Radius	3' 2-1/4"	3' 2-1/4"	3' 2-1/4"	3' 2-1/4"	3' 2-1/4"	3' 2-1/4"	3' 2-1/4"
R.O. Leg Height	14.391"	13.719"	12.938"	12.016"	13.953"	13.484"	11.813"
Visible Glass	17-1/4" x 11-1/4"	21-1/4" x 11-1/4"	25-1/4" x 11-1/4"	29-1/4" x 11-1/4"	33-1/4" x 11-1/4"	37-1/4" x 11-1/4"	49-1/4" x 11-1/4"

						
Base Code	MEA1-5012	MEA1-5812	MEA2-1812	MEA2-2012	MEA2-2412	MEA2-2812
Unit Dimension	5' 1-1/2" x 1' 3-1/2"	5' 9-1/2" x 1' 3-1/2"	3' 7-1/2" x 1' 3-1/2"	4' 3-1/2" x 1' 3-1/2"	4' 11-1/2" x 1' 3-1/2"	5' 7-1/2" x 1' 3-1/2"
Rough Opening	5' 2" x 1' 4"	5' 10" x 1' 4"	3' 8" x 1' 4"	4' 4" x 1' 4"	5' 0" x 1' 4"	5' 8" x 1' 4"
Soft Metric R.O. (mm)	1575 x 406	1778 x 406	1118 x 457	1321 x 406	1524 x 406	1727 x 406
R.O. Radius	11' 6-5/8"	11' 6-5/8"	7' 5"	7' 5"	11' 6-5/8"	11' 6-5/8"
R.O. Leg Height	12.516"	11.547"	13.234"	12.125"	12.734"	11.797"
Visible Glass	57-1/4" x 11-1/4"	65-1/4" x 11-1/4"	39-1/4" x 11-1/4"	47-1/4" x 11-1/4"	55-1/4" x 11-1/4"	63-1/4" x 11-1/4"

### 1/2 Round Direct Set Radius Units

(sized for Double Hung Windows)

						
Base Code	HRA1-20	HRA1-24	HRA1-28	HRA1-30	HRA1-34	HRA1-44
Unit Dimension	2' 1-1/2" x 1' 2-1/8"	2' 5-1/2" x 1' 4-1/8"	2' 9-1/2" x 1' 6-1/8"	3' 1-1/2" x 1' 8-1/8"	3' 5-1/2" x 1' 10-1/8"	4' 5-1/2" x 2' 4-1/8"
Rough Opening	2' 2" x 1' 2-5/8"	2' 6" x 1' 4-5/8"	2' 10" x 1' 6-5/8"	3' 2" x 1' 8-5/8"	3' 6" x 1' 10-5/8"	4' 6" x 2' 4-5/8"
Soft Metric R.O. (mm)	660 x 371	762 x 422	864 x 473	965 x 524	1067 x 575	1372 x 727
Visible Glass	21-1/4" x 9-7/8"	25-1/4" x 11-7/8"	29-1/4" x 13-7/8"	33-1/4" x 15-7/8"	37-1/4" x 17-7/8"	49-1/4" x 23-7/8"

						
Base Code	HRA1-50	HRA1-58	HRA2-18	HRA2-20	HRA2-24	HRA2-28
Unit Dimension	5' 1-1/2" x 2' 8-1/8"	5' 9-1/2" x 3' 0-1/8"	3' 7-1/2" x 1' 11-1/8"	4' 3-1/2" x 2' 3-1/8"	4' 11-1/2" x 2' 7-1/8"	5' 7-1/2" x 2' 11-1/8"
Rough Opening	5' 2" x 2' 8-5/8"	5' 10" x 3' 0-5/8"	3' 8" x 1' 11-5/8"	4' 4" x 2' 3-5/8"	5' 0" x 2' 7-5/8"	5' 8" x 2' 11-5/8"
Soft Metric R.O. (mm)	1575 x 829	1778 x 930	1118 x 600	1321 x 702	1524 x 803	1727 x 905
Visible Glass	57-1/4" x 27-7/8"	65-1/4" x 31-7/8"	39-1/4" x 18-7/8"	47-1/4" x 22-7/8"	55-1/4" x 26-7/8"	63-1/4" x 30-7/8"

## 1/2 Round Direct Set Radius Units

(sized for Gliding Windows)



HRA1-26



HRA1-30



HRA1-36

Base Code	HRA1-26	HRA1-30	HRA1-36
Unit Dimension	2' 5-1/2" x 1' 4-1/8"	2' 11-1/2" x 1' 7-1/8"	3' 5-1/2" x 1' 10-1/8"
Rough Opening	2' 6" x 1' 4-5/8"	3' 0" x 1' 7-5/8"	3' 6" x 1' 10-5/8"
Soft Metric R.O. (mm)	762 x 422	914 x 498	1067 x 575
Visible Glass	25-1/4" x 11-7/8"	31-1/4" x 14-7/8"	37-1/4" x 17-7/8"



HRA1-40

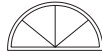

HRA1-50

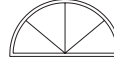

HRA1-60

Base Code	HRA1-40	HRA1-50	HRA1-60
Unit Dimension	3' 11-1/2" x 2' 1-1/8"	4' 11-1/2" x 2' 7-1/8"	5' 11-1/2" x 3' 1-1/8"
Rough Opening	4' 0" x 2' 1-5/8"	5' 0" x 2' 7-5/8"	6' 0" x 3' 1-5/8"
Soft Metric R.O. (mm)	1219 x 651	1524 x 803	1829 x 956
Visible Glass	43-1/4" x 20-7/8"	55-1/4" x 26-7/8"	67-1/4" x 32-7/8"